

PRODUCT MANUAL

ver 2024-05-13

SOLAR CONTROLLER FOR HEATING WATER, BOILERS

GREEN BOOST 4000 BYPASS

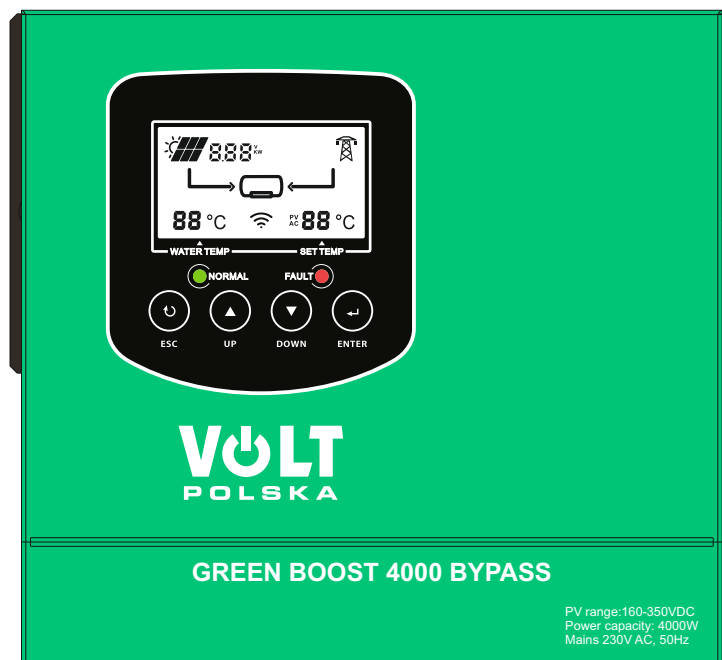

VOLT
POLSKA

VOLT POLSKA Sp. z o.o.
ul. Świeмиrowska 3
81-877 Sopot
www.voltpolska.pl

pomoc@voltpolska.pl | hurt@voltpolska.pl | (58) 500 85 62

CATALOGUE

1. Important safety instructions	1
About the manual	2
2. Introduction	3
2.1 Overview	3
2.2 Appearance feature	3
2.3 Datasheet	5
2.4 System diagram	7
3. Installation notes	8
3.1 Getting started	8
3.2 Installation	9
4. Operation instructions	15
4.1 Maximum power point tracking technology	15
4.2 Maximum water temperature setting	15
4.3 Protection function	16
4.3 Alarm function	16
4.4 Inspection and Maintenance	17
5. Common trouble shooting	19
6. Warranty service regulations and Repair process	20
6.1 Warranty service regulations	20
6.2 Repair process	21

1. Important safety instructions

To ensure your safety, please read the user manual carefully before installing and using the MPPT solar electric heating controller, and keep this manual for future use.

The following symbols are used in this manual to indicate potentially hazardous conditions or to mark important safety items.



WARNING !

This mark indicates that there is a danger when perform.



CAUTION!

This mark indicates the key operation steps to ensure the safe operation of the controller.



NOTE!

This mark indicates the safe operation and correct operation procedures of the controller.

Security Information.

Read the instructions and precautions in this manual carefully before starting the installation.

It is not allowed to disassemble the controller for private maintenance

Before installing or moving the controller, be sure to disconnect all power supplies connected to the controller.

During the operation of the controller, heat will be emitted inside the body, which may cause skin burns. The controller should be installed in a location that is not easy to touch.

Use insulated tools when connecting the power cord.

Do not wear jewelry when installing the controller.

The power cord connection must be fastened to prevent the power connector from overheating to catching fire due to the loose power cord.

Use wires and circuit breakers of appropriate specifications.

About the manual

This manual provides detailed installation and operating instructions for the MPPT solar electric heating controller. The installer of the controller should have qualified electrical skills and be familiar with the design and wiring rules of the solar system.

The installation information in this manual is for professional operators.

2. Introduction

2.1 Overview

The MPPT solar electric heating controller (hereinafter referred to as the controller) is to provide the electric energy which generated by the solar panel, to the electric heating rod with the maximum efficiency through the MPPT technology. It converts PV direct current into square wave alternating current, which can be used to connect to traditional utility water heaters directly.

The controller comes with intelligent control function, solar and AC switching intelligently.

Please read this operation manual. This will help you make full use of the advantages of the controller to establish an optimal solar photovoltaic electric heating system.

2.2 Appearance feature

The appearance characteristics of the controller and the function description of each part are shown in the figure below.

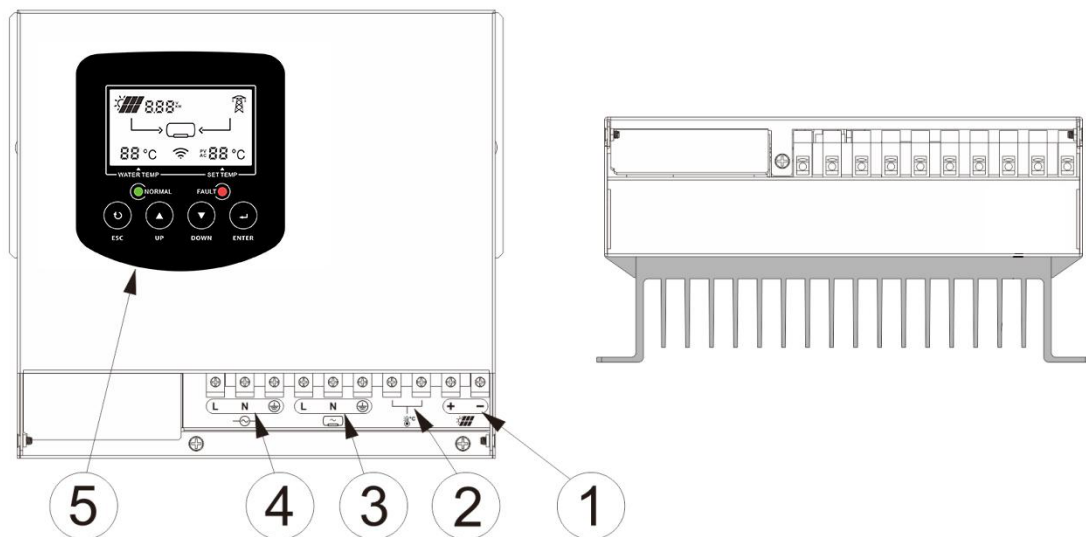

①---PV input terminal

+ Connect PV positive (+)

- Connect to PV negative (-)

②---Temperature detection terminal

③---AC OUTPUT terminal interface

L-----Connected to water equipment L line

N-----Connect water equipment N line

PE-----Ground wire for water equipment

④---AC INPUT terminal interface

L-----Connected to AC grid L line

N-----Connect to AC grid N line

PE----Connect to AC Grid Ground line

⑤---LED operator panel

LED display: Displays the current operating mode and
Displays the current temperature

Green indicator: indicates Normal status

Red indicator: indicates fault status

ESC button: Cancel/Return

UP button: Switch to the previous mode

DOWN button: Switch to the next mode

ENTER button: Confirm

2.3 Datasheet

Rated power	4000W
Scope of application	The MPPT water heating controller is only suitable for heating resistance heating components through solar power, and the controller load can only be used to connect resistance equipment or AC heaters, heating power within 360V/4000 watts.
Photovoltaic characteristics	
Solar Max. input power	4000 W
Solar input current	≤ 20 A
Solar input voltage range	160 Vdc~350Vdc
MPPT operating voltage range	120 Vdc~340Vdc
MPPT efficiency	>99%
Solar heating output current range	≤ 20 A
AC characteristics	
AC heating rated power(bypass)	4000 W
AC rated voltage	230 Vac
AC working voltage range	180 Vac~260 Vac
AC rated current	≤ 20 A
Load requirement	
Load	The load should not be higher than 230V/4000W, and the resistance value

	isn't less than 13 ohms
Machine characteristics	
Machine dimensions	195*183*100 mm
Package dimensions	255*246*158mm
Net weight	2.4 Kg
Gross weight	2.75 Kg
Ingress Protection	IP33

2.4 System diagram

2.4.1 Working principle diagram

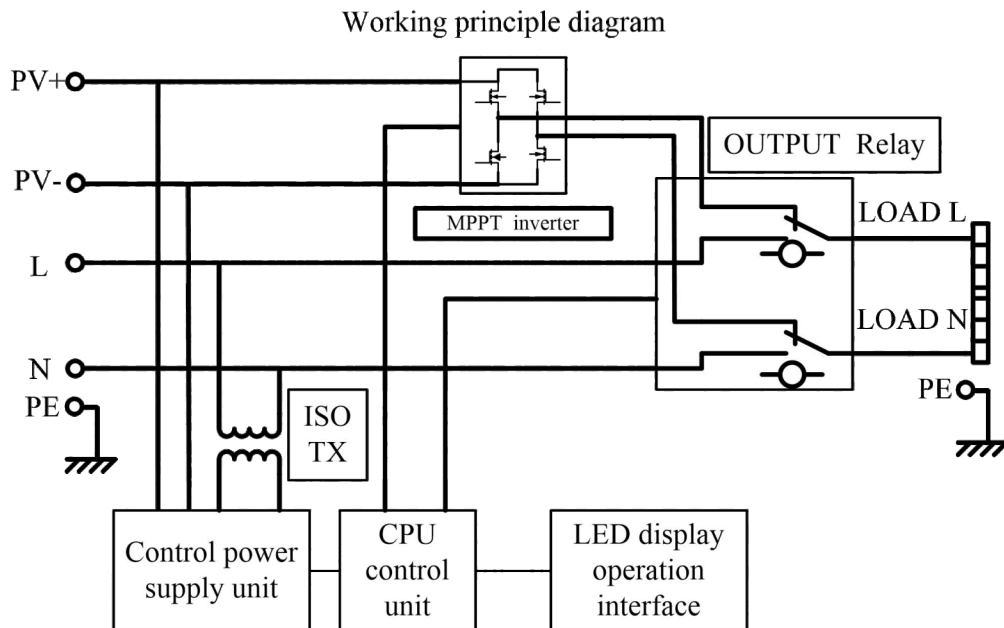

2.4.2 System wiring diagram

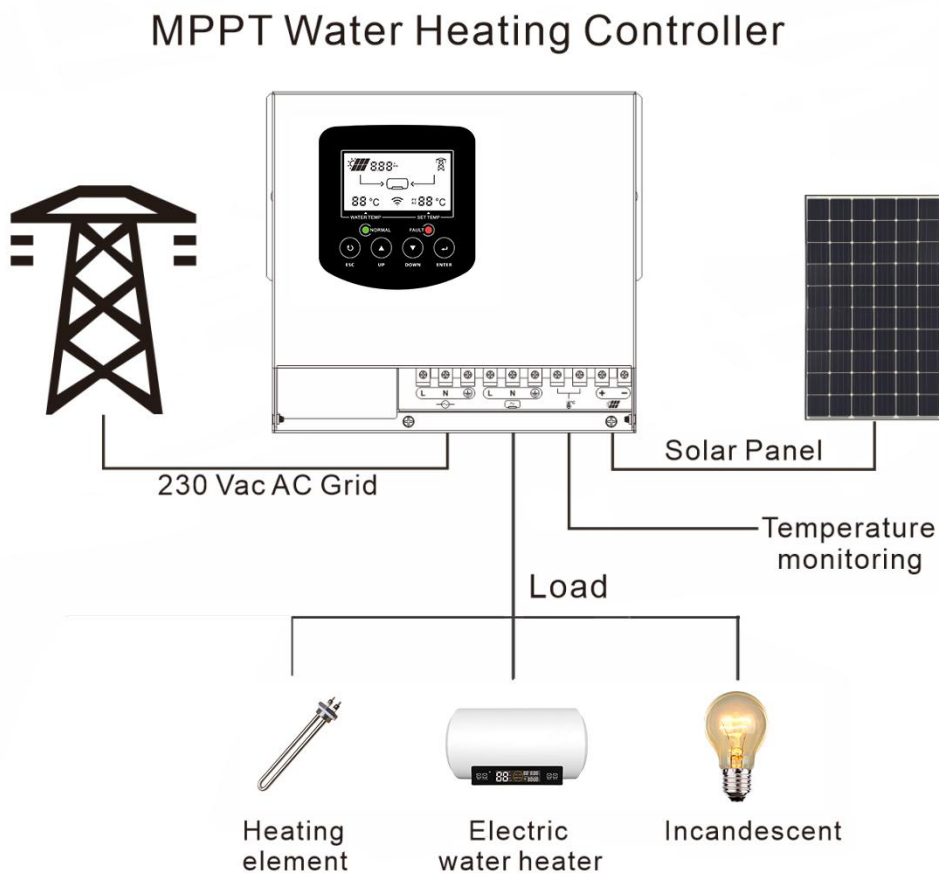

3. Installation notes

3.1 Getting started

The installation environment is critical to the performance and service life of the controller. The controller is recommended to be installed in a dry environment and prevent water infiltration. It is best to ensure sufficient ventilation around the controller and sufficient air flow.

Never install the controller in a sealed box !

This controller cannot be used in parallel !



Warning: Risk of equipment damage!

If the controller is installed in a box, make sure that there is sufficient ventilation inside and outside the box. A closed environment will cause the temperature of the controller to rise too high and reduce the service life of the controller.

Please read all installation instructions carefully before installing the controller, and operate strictly according to the requirements. Any inappropriate operation behavior may cause damage to the controller and affect the normal use.

Install spare tools:

Wire stripper

Wire cutter

Phillips screwdriver

Crimping tool

Inflatable drill

Level

Hacksaw (used for cutting pipelines with protective wires)

Wall nail

3.2 Installation

3.2.1 Wire diameter selection

It is very important to choose a suitable cable diameter for the controller. Generally, at least ensure that the voltage drop of the cable from the controller to the solar panel, the controller to the heating rod, and the controller to the water dispenser is less than 2% of the system voltage.

The following table provides the minimum wire diameter requirements at an ambient temperature of 45 degrees Celsius:

	Maximum current	Cable material	Recommended wire diameter	Minimum required wire diameter
Between controller and photovoltaic panel	20A	copper	6.0mm ²	4.0mm ²
Between controller and load	20A	copper	6.0mm ²	4.0mm ²
Between controller and AC input	20A	copper	6.0mm ²	4.0mm ²

3.2.2 Heating rod selection

Output interface: heating load power is no more than 230V/4000W, resistance value isn't less than 13 ohms.

Wall mount installation



Note: Wall-mounted installation is important! The wall or mounting frame on which the controller is installed must be able to bear the weight of the controller to prevent personal injury and machine damage caused by the controller falling off!

The controller is required to be perpendicular to the mounting surface, If the installation angle deviates from the vertical direction by more than 45 degrees, it will cause poor heat dissipation of the controller, which may affect the power output of the controller.

3.2.3 Wall mounted installation

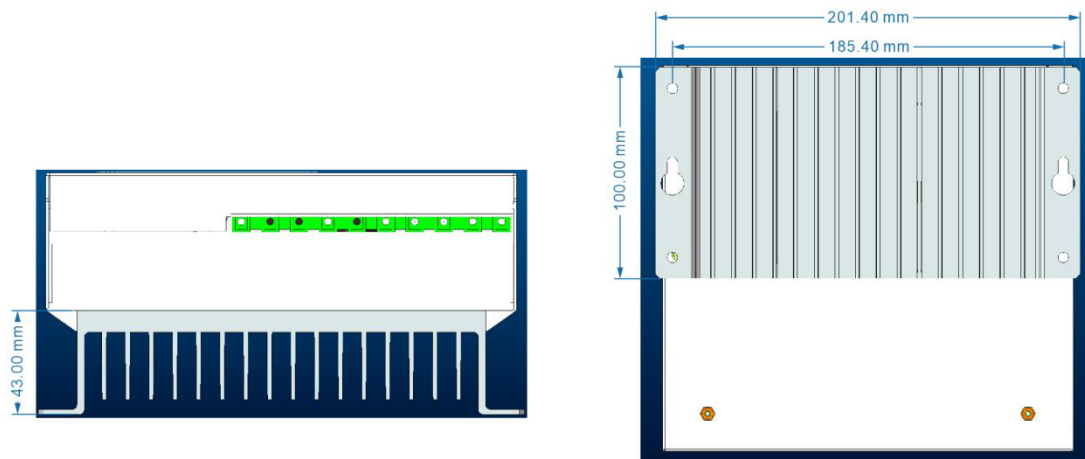

Choose any set of mounting holes, and install the controller vertically on the wall with expansion screws.

3.2.4 Remove the wiring cover

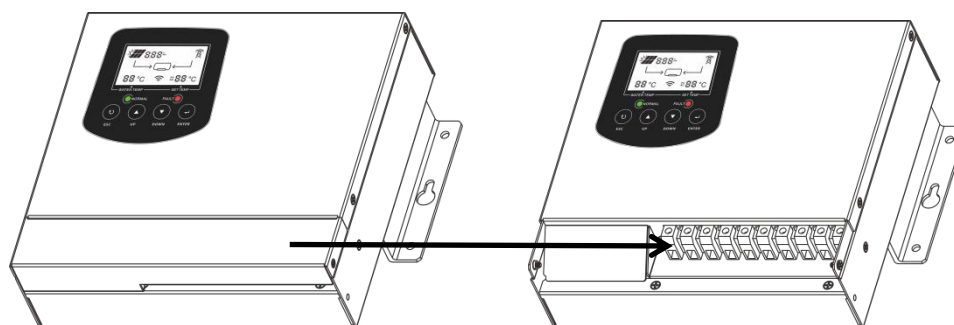



Warning: Electric DANGER !

Before removing the wiring cover, please make sure that the controller is disconnected from all power sources, and let the controller stand for more than 5 minutes to ensure that the residual power inside the controller is discharged to a safe level. Any live operation will put the operator in a dangerous situation and may cause damage to the controller. Remove the wiring cover as shown in the figure below.

3.2.5 Power cord connection



Warning: Risk of electric shock!

The maximum open circuit voltage of the solar panel array should not exceed the maximum value of 420VDC specified by the controller. Before installation, make sure that the solar panel and the cable are disconnected.

Follow the steps below to connect the terminals shown in the figure above:

Before wiring, make sure that all the breakers are connected to the controller are in the off status.

There is no breaker inside the controller.



Warning ! Note that the positive and negative poles of the solar panel cannot be reversed!



Warning ! Note that it must be ensured that the ground is wired correctly !



Warning ! Note that if you choose a heating load that exceeds the rated power, the controller will be damaged!

1. **Connect the solar panel + (positive) wire to the PV+ terminal on the controller.**

Connect the solar panel-(negative) wire to the PV- terminal on the controller.

2. **Connect the LOAD wire to the OUTPUT terminal of the controller. Please select the LOAD with the correct power, the LOAD power is not more than 230V/4000W, and the resistance value isn't less than 13 ohms.**

Load L line to OUTPUT L;

Load N line to OUTPUT N;

Load PE line to OUTPUT PE.



Warning ! The controller is only suitable for using solar power to heat resistance heating components, and the controller load can only be used to connect resistance heating equipment with a mains heating power within 230V/4000 watts, such as AC water heaters, heating wires, heating rods, PTC. Capacitive or inductive loads may cause controller damage.

3. **AC input connection.** Connect the AC Grid line to the AC in terminal on the controller.

AC Grid L line to AC IN L;

AC Grid N line to AC IN N;

AC Grid PE line to AC IN PE.

3.2.6 POWER-ON



Warning ! Pay attention to the terminal mark!

Connecting the photovoltaic to the AC IN or AC OUT terminal or connecting the AC IN to the photovoltaic connection terminal or connecting the AC IN to AC OUT connection will cause the controller irreversible damage.



Warning ! Note that the polarity is correct!

If the positive and negative poles of the solar cell array are connected reversely, the controller will not work normally.



Warning ! Note that before powering on, you must make sure that the ground is wired correctly. Poor ground wiring will affect the mains leakage protection function of the controller and cause danger to the user!

Confirm that the polarity of the solar cell array is correct.

Confirm that the ground wire of the mains plug is in good condition.

Close the PV input breaker. If the voltage from the solar panel is suitable at this time, the controller will start to use solar energy for heating.

Close the AC input breaker. If the voltage from the solar panel is not available, will switch to AC in and AC out.

3.2.7 POWER-OFF



Warning ! Pay attention to the power-off sequence!

After ensuring that the AC connected to the controller and the solar panel connected to the controller are completely disconnected, can remove other cables.







4. Operation instructions







After the MPPT controller installed, it will operate smartly. Solar is the first priority source, when solar is insufficient, will switch to AC automatically.

4.1 Maximum power point tracking technology

The maximum power point tracking technology can detect the power generated by the solar panel in real time and track the maximum power generated by the solar panel to ensure that the solar cell array can work at the current maximum power point. This process is automatically realized by the DSP through a series of calculations.

4.2 Maximum water temperature setting

Maximum PV heating water temperature setting. On the operation panel, press the up key , the PV temperature setting display , and then press the enter key  highest water temperature setting number flashes, press the up  and down  keys, select the PV highest water temperature to be set (choose between 55°C and 80°C), press the enter key , the number stops flashing, the setting is complete, or press the esc key , the number stops flashing, the setting is canceled. When PV is heated, the water temperature reaches the maximum water temperature of the set PV heating, the PV stops heating, and when the water temperature drops to 3 °C below the maximum water temperature of the set PV heating, the PV cancels to stop heating.

Maximum AC heating water temperature setting. On the operation panel, press the up key , the AC temperature setting display , and then press the enter key  highest water temperature setting number flashes, press the up  and down  keys, select the AC highest water temperature to be set (choose between 30°C and 80°C), press the enter key , the number

stops flashing , setting is complete, or press the esc key  , the number stops flashing , setting is canceled. When AC is heated, the water temperature reaches the maximum water temperature of the set AC heating, the AC stops heating, and when the water temperature drops to 3 °C below the maximum water temperature of the set AC heating, the AC cancels to stop heating.

4.3 Protection function

Solar panel power is too high

The maximum output current of the controller is limited by the rated value. When the power of the solar cell array connected to the controller exceeds the rated maximum value, the maximum output power of the controller will be limited within the rated value, at this time, the controller may not work at the solar cell array maximum power point. The utilization rate of the solar cell will be reduced.

Solar panel input line short circuit

When the solar panel input line is short-circuited, it is equivalent to no solar input. After the short-circuit is removed, the controller will automatically resume normal operation.

Over temperature protection

If the ventilation around the controller is poor, the temperature of the controller body will be too high, exceeding the normal operating temperature range, the controller will continuously reduce the photovoltaic output power until the output stops. When the body temperature drops below the protection temperature, the controller automatically restores output.

4.3 Alarm function

AC input voltage high alarm

When the AC voltage exceeds 260VAC, the Fault indicator will be lit, the AC output will be cut off. If the voltage drops below

260VAC, the Fault indicator will be off, and the controller recovers to operate.

PV input voltage high alarm

The open circuit voltage of the solar cell array connected to the controller should be less than exceeds the rated maximum value. If the open circuit voltage of the solar cell array exceeds the maximum input voltage specified by the controller, the controller will stop working or even be damaged.

4.4 Inspection and Maintenance

Please carry out the following inspections twice a year to extend the service life of the controller.

4.4.1 System check

Confirm whether the controller is installed firmly and whether the surrounding environment is clean enough.

Confirm that there is good ventilation around the controller, and clean the dust and debris on the surface of the controller.

Check whether the external power cord is damaged due to aging, rubbing, insects or small animals biting, Insulation skin, etc. If damaged, please replace it in time.

Check whether the external power cord is loose, and tighten the loose power cord further.

Check that the LED indications are consistent with the operation of the equipment. If you find any faults or wrong indications, please take immediate measures to correct them.

Check whether all grounding wires of the system are well grounded.

4.4.2 Inspection of controller wiring cover



Note: Danger of electric shock!

Before removing the wiring cover, make sure that all power supplies connected to the controller are disconnected. If the power has not been disconnected, do not open the controller wiring cover. Please open the controller wiring cover 5 minutes after all power is disconnected.

Check whether the power cord in the junction box is damaged due to aging, rubbing, insect or small animal bites, etc. If there is any damage, please repair and replace it in time.

Check whether the power cord in the junction box is loose, and tighten the loose power cord further.

5. Common trouble shooting

1. There is no LED indicator, and the controller appears to have no electrical connection and does not turn on.

Solution:

Use a multi-meter to measure the voltage across the terminals of the photovoltaic panel of the controller. The voltage of the photovoltaic panel terminal must be above 160 VDC for the controller to operate. If the voltage at both ends of the photovoltaic panel terminal of the controller is between DC 160V and 350V, and there is no LED display, please contact your local dealer.

Use a multi-meter to measure the voltage between the AC socket L-N and the AC voltage range. The voltage must be above AC 180V. If the voltage between the AC socket L-N is between AC 180V and 260V, check whether the AC plug is properly inserted, or connected well. If no LED display, please contact your local dealer.

If no voltage is measured at both ends of the photovoltaic panel wiring terminals of the controller, please check whether the photovoltaic cable is in good condition, and whether there is a fuse or circuit breaker on the circuit. If the AC socket does not have the voltage, please check whether the AC is normal.

2. The red fault light is indicator

Solution:

Check whether the controller triggers a protection condition of 4.2 or a failure condition of 4.3. If no triggers, please contact your local dealer.

6. Warranty service regulations and Repair process

6.1 Warranty service regulations

Within 15 months from the date of production, all non-human being performance failures of the controller occurred. Please contact your local dealer to provide warranty service.

Non-warranty regulations

The following situations (but not limited to the following situations) are not covered by the warranty service:

Human being-made damage caused by accident, negligence, improper installation or improper use.

Damage caused by solar cell voltage, power or load current exceeding the rated value.

The controller is damaged due to the selection of over-specification heating rods.

Modify or repair the product without authorization.

Damage occurred during transportation.

Damage caused by natural disasters such as lightning and extreme weather.

Damage caused by irresistible factors such as fire and flood.

It is specially stated that the scope of use of the controller defined in the specification is unique, and any over-range application promise without the authorization of the manufacturer will not be recognized by the manufacturer.

Without the authorization of the manufacturer, anyone has no right to make any modification or extension of the warranty. The manufacturer is not responsible for the economic losses caused by this.

WARRANTY CARD

DATE OF PURCHASE	
SHIPPING ADDRESS	
SIGNATURE / STAMP	
DAMAGE DESCRIPTION	
SERVICE COMMENTS	

FILL IN IF NEEDED

(*) Cross incorrect

I agree to pay the cost of inverter repair due to:

* expiration of the warranty period / * warranty void

Before proceeding with the repair, service will inform by phone about the exact costs of the repair.

Please attach a copy of the purchase document (receipt or invoice) to the complaint.

The full regulations of service repairs can be found on our website www.voltpolska.pl

Proper disposal of the product (waste electrical and electronic equipment)

The marking placed on the product or in the texts related to it indicates that it should not be disposed of with other household waste at the end of its useful life. To avoid harmful effects to the environment and human health from uncontrolled disposal, please separate this product from other types of waste and recycle responsibly to promote the reuse of material resources as a continuing practice. For information on where and how to recycle this product in an environmentally safe manner, residential users should contact the retailer where they purchased the product, or their local government authority. Business users should contact their supplier and check the terms and conditions of their purchase contract. The product should not be disposed of with other commercial waste.

