

SIMPO 5000

Installation & Operating Manual (EN)

ZYC ENERGY
ZERO YOUR CARBON

Version: V1.4.3
Released Date: 2024-12-05



Contents

1. Introduction.....	1
2. Glossary	1
3.Safety.....	1
3.1. Transportation.....	1
3.2. Handling	2
3.3 Storage.....	2
3.4 Leaking Batteries	2
3.5 Fire.....	2
3.6 Wet Battery	2
4.Product Information	3
4.1 Introduction.....	3
4.2 Battery Module:	3
4.3 Parts in package	3
4.4 Front Pannel.....	3
4.5 Specifications.....	4
4.6 Cabinet	5
5.Installation.....	6
5.1 Location And Environment Requirement.....	6
5.2 Cabinets.....	6
5.3 Battery Connections	6
5.4 Tools.....	6
5.5 Extra Accessories	7
5.6 Wire The Cabinet	8
5.7 Place The Cabinet.....	9
5.9 Cables connection	10
5.10 Connect To The Inverter	11
5.11 Switch to No Communication Mode	12
5.12 Multiple Cabinets In Parallel	12
5.13 Installation Without SIMPO Cabinet.....	13
5.14 Battery Orientation	15
5.15 Cables Connection Between Modules	16
6.Commissioning	16
6.1 Status LED	16
6.4 System Shutdown	17
6.2 Air Switch.....	17
6.3 System Start Up.....	17
6.5 Charging And Discharging	17
7.SIMPO WiFi Dongle	17
7.1 Introduction	17
7.2 Connect to Internet & WiFi Usage & ZYC Portal & ZYC Assist APP	18
7.3 Download ZYC Assist APP	18
8.Trouble Shooting.....	18
9.Compatible Inverters	18
10. Maintenance	18
11. Long-term Storage	19

1. Introduction

- SIMPO 5000 is an easy straightforward battery storage product, tailored for project installers who deeply involved in off-grid projects. It is a 51.2V DC battery system, with 5 kWh capacity in each battery unit. It's designed with 19' inch format, to fit seamlessly into any standard 19' racks.
- The key features of SIMPO 5000 are simple, flexible and reliable. The installation of SIMPO 5000 is easy and time-saving. And the cabinets included are pre-wired.
- SIMPO 5000 is a product that can handle projects of any size, it allows up to 64 units DC paralleled to run on a single inverter. You can choose different modes including CAN communication or Modbus RS485 or Non-Communication.
- It is a hot-swappable product which allows project with zero downtime. The air switch designed on the battery offers an easy shut down and protects the battery from over current. In addition, with the frontier low-temperature cell technology, SIMPO 5000 can discharge at -20°C and charge at -10°C which means it can provide reliable power back up for winter or mountain projects.
- SIMPO 5000 is fully compatible with global leading inverters and offers versatile choice for various off-grid system or solar energy system. It is with high current capability and matches a perfect power to size ratio with inverters which can maximize the power and minimize the required battery size.
- This document indicates the technical specification of SIMPO 5000 and provide guidance for the installation.

2. Glossary

Terms	Full name
BESS	Battery Energy Storage System
BMS	Battery Management System
LED	Light Emitting Diode
LFP	Lithium Ferro Phosphate(LiFePO4)
SOC	State of Charge
SOH	State of Health
DOD	Depth of Discharge

3. Safety

When installing, commissioning, operating and maintaining the product, the safety requirements in the manual should be strictly observed. Incorrect operation or work may lead to damage to the product and other properties or injury or death of the operator or third parties.

When fixing the product with screws or other parts, use the correct tool and reinforce it with the torque indicated in the manual or on the label of the product, otherwise the product may be unstable or damaged.

When using different tools, master the tools in advance to prevent the installer from being injured due to improper handling.

Please read this manual thoroughly before installation to ensure proper and safe installation and use of the product.



Warning & Caution

1. Installers and users are obliged to familiarise themselves with this manual.
2. Power Cables and plugs have high voltage from the battery, be careful when wiring.
3. Ensure that a fire extinguisher is in place prior to installation and use.
4. Installation and operation must be carried out by qualified personnel and the system must be installed in restricted access areas.
5. The battery module is with certain weight, it is better to be installed by at least two personnel. With the help of tools if necessary.

3.1. Transportation

Batteries should be shipped with the terminals covered to prevent contact with metal objects and short circuits during transport. Our batteries are discharged to a certain state of charge before shipment to you in order to comply with international transport regulations.

Where possible, batteries should be shipped in the manufacturer's arrangement, horizontally and secured. Prevent shipping vertically if possible, and with a limit on the number of batteries stacked on top of each other.

The battery should be placed out of the reach of children or animals to prevent injury due to accidental contact.

Do not place heavy objects on the battery to prevent damage to the battery

Ensure at least two people move the battery during transport or installation.

When disposing of discarded or damaged batteries, do not dispose of them with household waste.

3.2. Handling

- Batteries are heavy, it should be handled and installed with the proper number of personnel and the help of the correct tools.
- The installer should be cautious during installation to prevent damage to the battery. If the battery has been damaged before installation, including but not limited to shell damage, terminal port damage. Please do not use and contact the after-sale staff.
- Do not touch the DC bus or port of the battery directly.
- Avoid subjecting the battery to external forces, such as being dragged on the ground, or having heavy objects placed on the battery.
- Do not clean the battery or allow foreign objects to enter the battery.
- Do not unplug any cables directly while the battery is in operation.
- Do not use the battery together with batteries of other brands or types.

3.3 Storage

- If storage devices are not available, place the batteries horizontally and minimise the amount of stacking vertically.
- Do not store the battery in an environment that is exposed to direct sunlight or high humidity, and ensure that it is kept away from heat and water.
- If the battery is stored for a long period of time, the ambient temperature should be maintained at about 25°C. If the battery is only stored for a short period of time, the ambient temperature should also be ensured to be between 0°C and 35°C.
- Batteries stored for long periods of time (≥ 6 months) should be checked its voltage. If the battery voltage is less than 51.6V, then the battery should be charged periodically to prevent irreversible damage caused by low battery power.

3.4 Leaking Batteries

- Stop using damaged battery immediately and dispose of it in the correct place or return it to a professional.
- Damage to the battery may result in leakage of electrolyte, and lifting into the electrolyte may cause consequences such as breathing difficulties, skin irritation and chemical burns. When the following conditions occur, the following guidelines should be followed promptly.
- Eye contact Rinse gently with running water for at least 15 minutes and seek medical help promptly.
- Skin contact Rinse under running water for more than 15 minutes, remove any contaminated clothing and seek medical attention.
- Inhalation or ingestion Leave the contaminated area and seek medical assistance.

3.5 Fire

Fire may occur with the battery if the battery is too close to a flame or the temperature of the environment is unusually high. Carbon monoxide, carbon dioxide, and other gases and emit smoke may occur if the battery is on fire. Empty the fire area in a timely manner, use a full-face self-contained breathing apparatus (SCBA) with full protective gear during fire fighting and use a dry chemical fire extinguisher to cool and extinguish the battery to prevent the fire from spreading.

3.6 Wet Battery

If the battery is submerged in water, stop using it immediately and seek help from ZYC ENERGY employees. Wear rubber gloves and boots in advance if you need to disconnect power or may be in the same liquid environment as the battery.

4. Product Information

4.1 Introduction

Simpo 5000 is a residential energy storage system designed by ZYC ENERGY. This battery has an internal battery management system(BMS), which monitors the status of the battery and protects the battery in time when improper operation occurs, improper operation includes:

- Overcharging or over-discharging
- Too high or too low temperature
- Overcurrent or short circuit

At the same time, in order to better protect the battery, we also designed an air switch for it, which can protect the battery in time when the above improper operation occurs.

4.2 Battery Module:



Figure 4.1

4.3 Parts in package

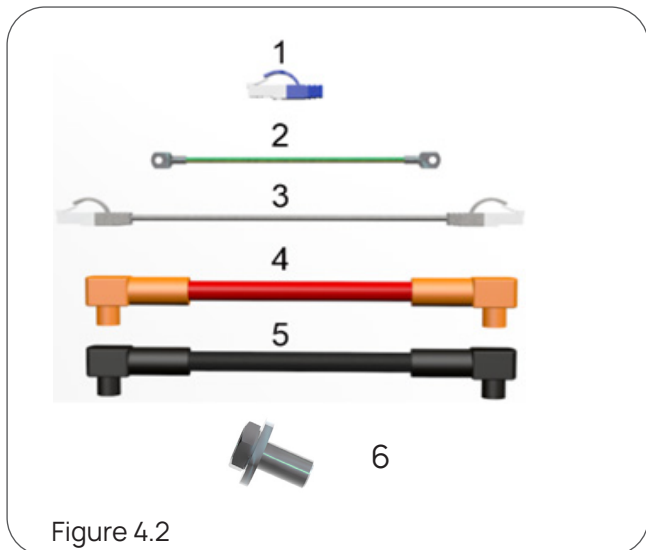

Figure 4.2

Number	Part Name
1	Terminal resistor
2	PE Cable
3	Communication Cable
4	Power Cable(+)
5	Power Cable(-)
6	Bolt M6 × 14 (4 PCS)

4.4 Front Panel

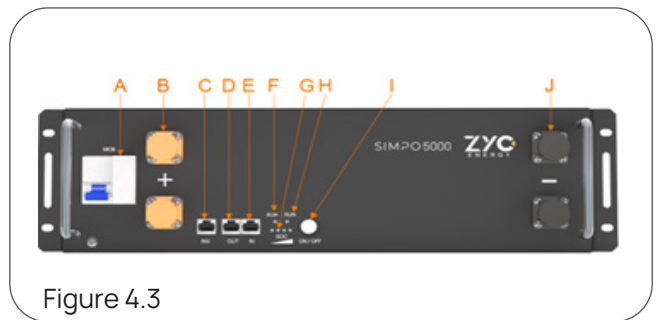

Figure 4.3

Letter	Label	Function
A	MCB	Circuit Breaker
B	+	DC+
C	INV	Inverter Com
D	OUT	Parallel Com Out
E	IN	Parallel Com In
F	ALM	Alarming LED
G	SOC	SOC Indicator
H	RUN	Status LED
I	ON/OFF	Switch On/OFF
J	-	DC-

4.5 Specifications

SIMPO 5000	Specifications
Nominal DC Voltage	51.2V
Operational Voltage Range	40.8V to 58.08V
Usable Capacity	5.12kWh/100Ah
Depth of Discharge	100%
Maximum Continuous Discharge C-Rate	1C (@25°C)
Maximum Continuous Discharge Current	100A (@25°C)
Maximum Continuous Discharge Power	5.12kW
Peak Discharge Current	200A (10.24kW, 5s)
Maximum Continuous Charge C-Rate	1C (@25°C)
Maximum Continuous Charge Current	100A (@25°C)
Peak Charge Current	200A (5s)
Circuit Breaker	1-Pole 125A 80VDC
Lithium Composition	LiFePO ₄ or LFP (Lithium Iron Phosphate)
Operating Temperature Range	Charge: -10°C to 55°C / Discharge -20°C to 55°C
Operating Humidity	Up to 95% (Non-condensing)
BMS Over-Volt Cell Level Protection	3.75V
BMS Under-Volt Cell Level Protection	2.55V
BMS Over-Temp Cut Off	56°C
Short Circuit Current	4500A
Altitude	< 2500m
Mounting Options	SIMPO Cabinet 6/10
DC Connectors	120A (UL 4128 & TUV 2Pfg 2740)
DC cables requirement	4AWG
IP Rating	IP20
Efficiency	>95%
Cooling	Natural
Scalability	Max 64 units in Parallel
Series Connection	Not Permitted
Communications	CAN 2.0A / RS485 / No Com
Module Weight	44 kg
Dimension (WxHxD)	482x134x518 mm
Warranty	10 Years (Conditions apply)

Certifications

Cell	UL1973, UL9540A, IEC62619:2022, UN38.3
Pack	IEC62619:2022, IEC62040, UN38.3, CE, CEC

4.6 Cabinet

ZYC provides 2 cabinet options, 6 units parallel and 10 units parallel option. Pre-installed cables allow quick and easy installation. Plug & Play.



SIMPO Cabinet 6



SIMPO Cabinet 10

Specification	SIMPO Cabinet 6	SIMPO Cabinet 10
Dimension (W x D x H)	620 x 600 x 1270mm	620 x 600 x 1890mm
Fixation	4 x wheels for easy moving and 4 feet for load-bearing	
Max. Qty of modules	6(30kWh)	10(50kWh)
Max. continuous current (Busbar)	625A (with M10 nut bolting)	1250A (with M12 nut, bolting)
Battery Interconnection	Pre-wired quick connector with 4AWG UL cable	
DC circuit breaker	None	
Cable entry	Top entry	
IP rating	IP20	
Communication Cable	Cat5 / 3 m (Delivered with cabinet)	
Net Weight	90kg	120kg

5. Installation

This session provides important information and detailed guidelines for installing the product to ensure a safe and smooth installation process. Installation should be well considered and all the specification of the battery should be understood to determine a suitable location and way for the installation.

5.1 Location And Environment Requirement

The location of battery installation should be suitable for safe operation and long-term use. If you choose not to purchase our cabinet or bracket, please install the battery in a 19" data rack assembly or other compliant and safe electrical enclosure of your choice. Our cabinets can be used both indoors and outdoors, so please choose a location where the battery can be easily connected and serviced. In addition, the battery installation location should be chosen to meet the following conditions as much as possible:

- Do not expose the battery to high temperatures or any sources of heat such as fire, transformers and heaters. It may cause a fire if the battery overheats. The distance between the battery and heat source should be at least 5 meters.
- SIMPO 5000 and SIMPO Cabinet are both designed to be installed and used indoors.
- The installation environment is free of flammable and explosive materials.
- Ambient temperature between 15-30 °C, air humidity between 0-95% and both temperature and humidity should keep as constant as possible.
- The ground is flat, no inclination angle or unevenness.
- Clean environment, no large amount of dust.
- Avoid direct sunlight, rain and snow.
- Well-ventilated with good air circulation.
- Keep away from children or pets to prevent injury by accident.
-

5.2 Cabinets

The batteries are designed to fit into a 600mm deep 19" equipment rack. ZYC has designed two types of cabinets to accommodate different numbers of modules, SIMPO Cabinet 6 for up to 6 modules and

SIMPO Cabinet 10 for 10 modules. Both cabinets are pre-wired and saving you a lot of time when setting up your battery system. You can choose the right cabinet to meet your needs.

If you plan to design and assemble your own battery enclosure, there are a few suggestions and advice for you.

- Ensure that the whole cabinet system meets IEC 62040 and equivalent safety standard.
- Your enclosures should be designed with rails where possible, if not, make sure they are well secured to prevent accidental damage.
- If you design your own battery enclosure, make sure that you do not stack more than 6 batteries unless you have designed the enclosure to share the weight of the batteries.
- Make sure that the environment where the batteries are located is not sealed or without air circulation, leave at least 25mm of clearance all around the battery pack.
- Ensure that all power cables you connect are of the same length and size.
- Choose the right material for the enclosure according to the location of the battery and make sure it has the correct IP rating.
- Make sure that your enclosure is properly connected to ground and that you have chosen the right fuses, cables, connections, etc.

5.3 Battery Connections

To save your time on power cables connections, SIMPO 5000 is designed with Exconn (non-keyed) connectors on both the positive and negative terminals. If you want to parallel multiple cabinets, you may need to purchase additional power cables and combiner box. When purchasing power cables, please make sure that the power cables are of the same length, so as to keep the impedance of each battery and cable set the same.

5.4 Tools

Tools below are necessary for the installation of Simpo 5000. Make sure you are well prepared before you start with your installation.

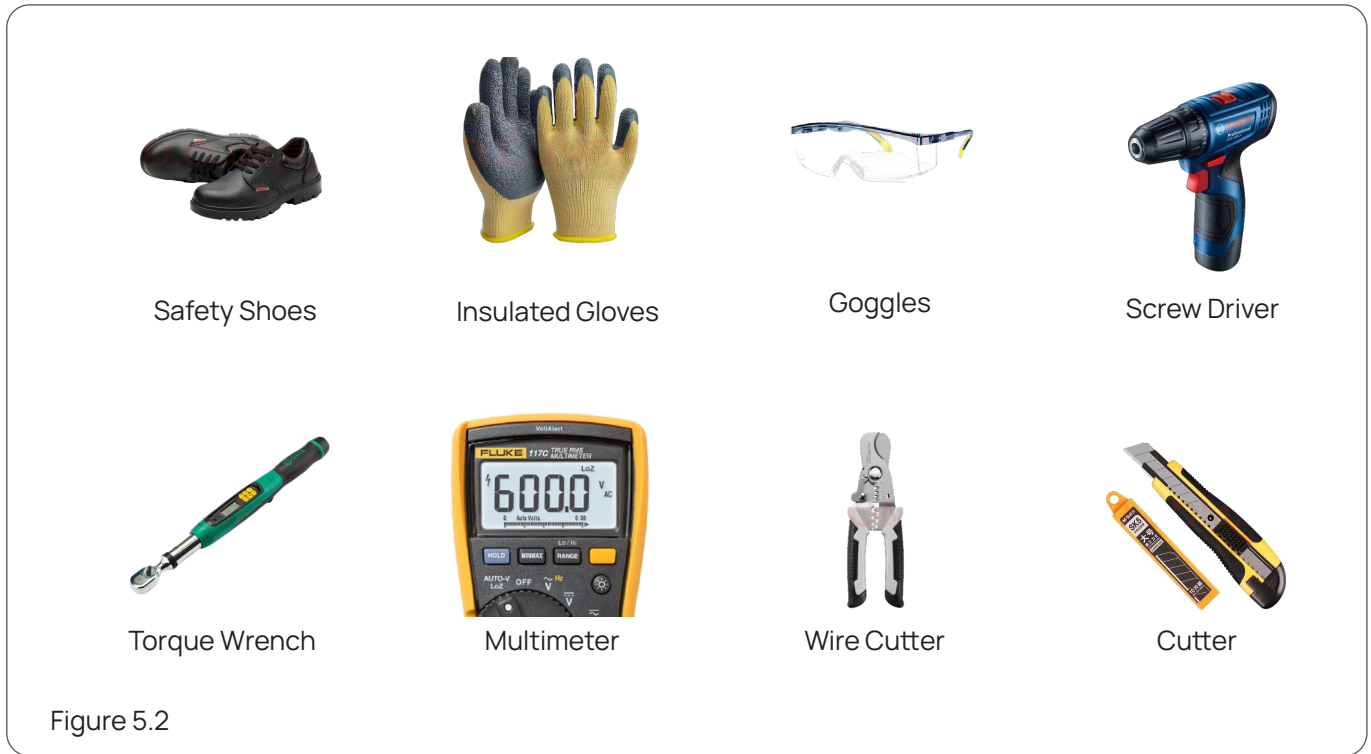

5.5 Extra Accessories

The parts below are not included in the accessories we offered, but necessary for connecting with inverter.

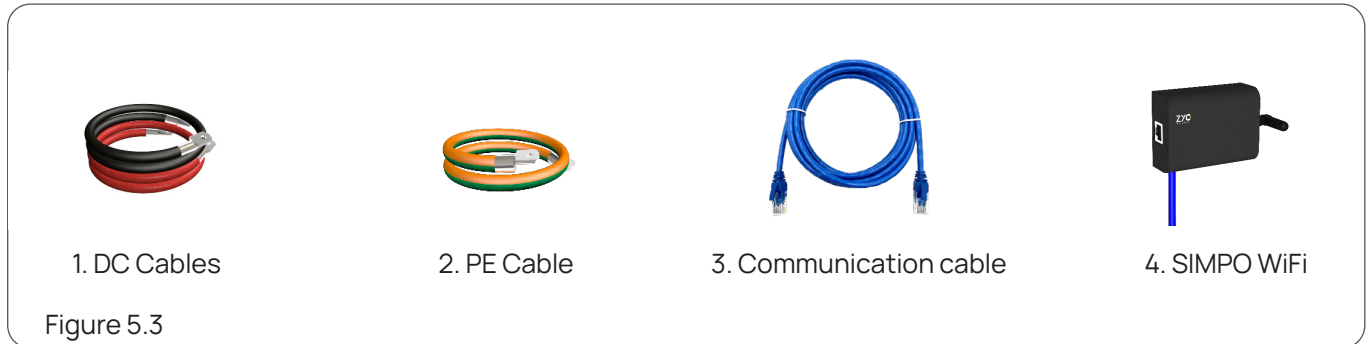

1. DC Cables with Terminals(1 pair or 2 pairs):

Table 5.1 Conductor's CSA (Cross Sectional Area) requirement:

Power	10 kW	20 kW	30 kW	40 kW	50 kW
CSA (1 pair cables)	≥70 mm ²	≥120 mm ²	--	--	--
CSA (2 pairs cables)	≥35 mm ²	≥70 mm ²	≥95mm ²	≥120 mm ²	≥150 mm ²

Terminal requirement:

SIMPO Cabinet 10:SC xxx-12; SIMPO Cabinet 6: SC xxx-10

"xxx" means the CSA of conductor

2. PE Cables(CSA≥25 mm) with Terminal(SC35-6).
3. Communication cable with shield (Cat5 or higher).
4. SIMPO WiFi can be bought from ZYC's dealers.

5.6 Wire The Cabinet

When you first receive the cabinet, please carefully check that there is no damage to the exterior of the cabinet and if the cabinet is damaged, contact ZYC ENERGY for assistance.

If the cabinet is all good, you can start to wire the cabinet following the steps below.

5.6.1 SIMPO Cabinet 10

Step1. Open the panel of cabinet



Figure 5.4

Step2. Find the two busbars and the PE cable connector.

The DC cables with Terminal: 1 pair or 2 pairs;
Conductor CSA(cross sectional area) requirement:
Refer to the table 5.1.

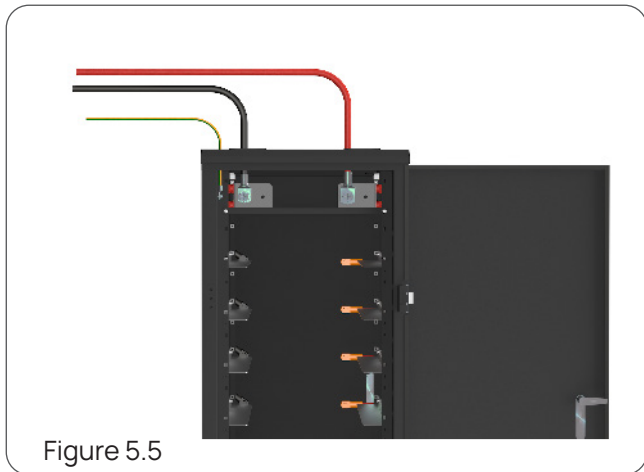

Figure 5.5

Step3. Connect Power cables:

Connect the two busbars and wire them through the top of the cabinet. The tighten torque of the bolts of Power cables is **20 N·m**.

Step4. Connect the PE cable to the cabinet.

Tighten the bolt with **5N·m**.

5.6.2 SIMPO Cabinet 6

The DC busbars are placed on two sides of the cabinet for cabinet 6.

Step1. Open the panels on two sides of cabinet. Remove the bolt, then the panels can be open.

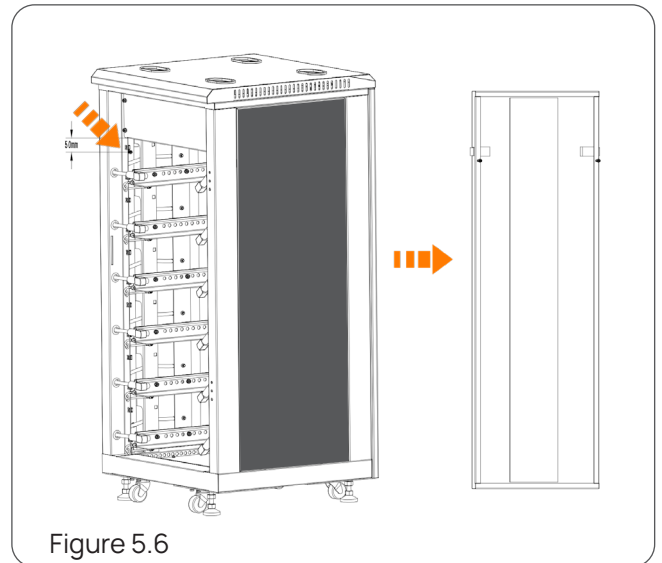

Figure 5.6

Step2. Connect Power cables:

Connect the two busbars and wire them through the top of the cabinet. The tighten torque of the bolts of Power cables is **15 N·m**.

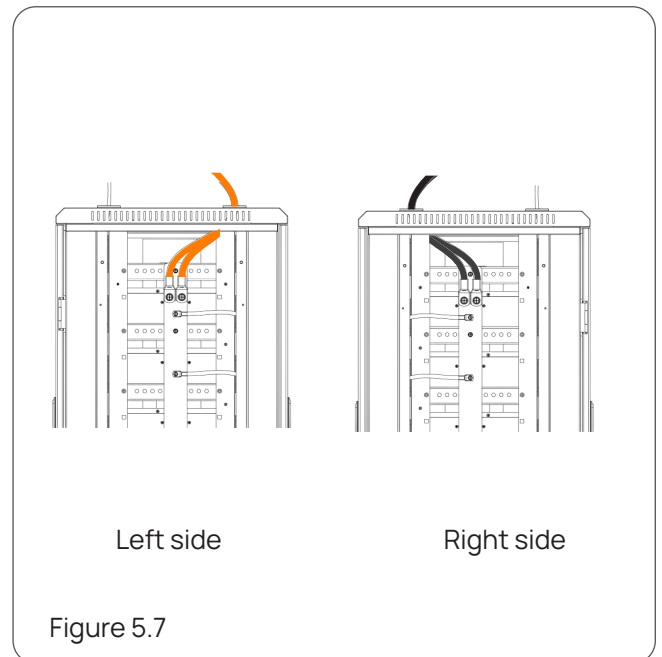

Figure 5.7

Step3. Connect the PE cable to the cabinet.

Tighten the bolt with **5N·m**.

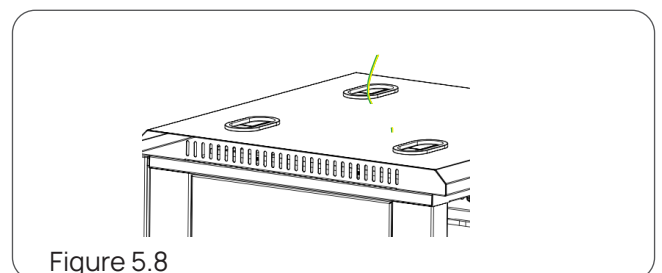

Figure 5.8

5.7 Place The Cabinet

After cable the cabinet, find a place that suit the conditions below:

- Avoid from salt air. If salt air is unavoidable, place a appropriate air filtration to keep the battery free of salt deposits.
- The floor is level.
- The area is of a clean environment with minimal dust.
- The cabinet and the battery should not be exposed to direct sunlight.
- It is easy to place the cabinet and the only operation needed is wrenching the four nuts on the feet of the cabinet.

Make sure that the feet are dropped down enough to support the cabinet, and the wheels are overhang. Do not move cabinet while batteries are installed.

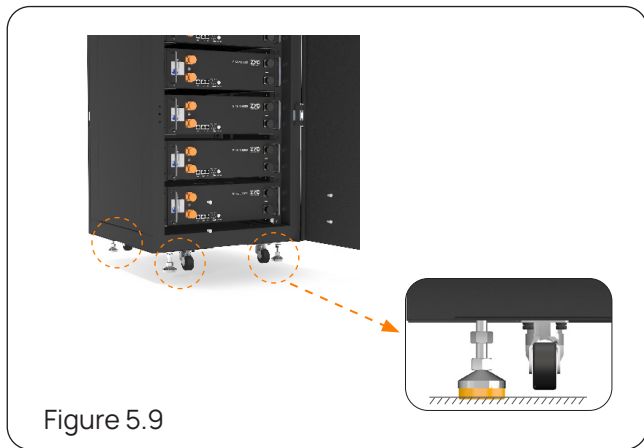

Figure 5.9

Minimum clearance requirement of cabinet:

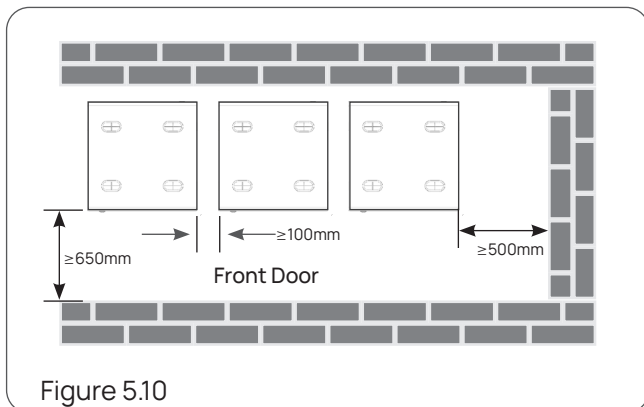

Figure 5.10

5.8 Battery Installation

5.8.1 Slide SIMPO 5000 In

This step is recommended to be accomplished by at least two personnel as each battery is weighted 44 kg.

Slide the battery in towards the track designed on each level. We recommend that you install the battery modules from the bottom up.

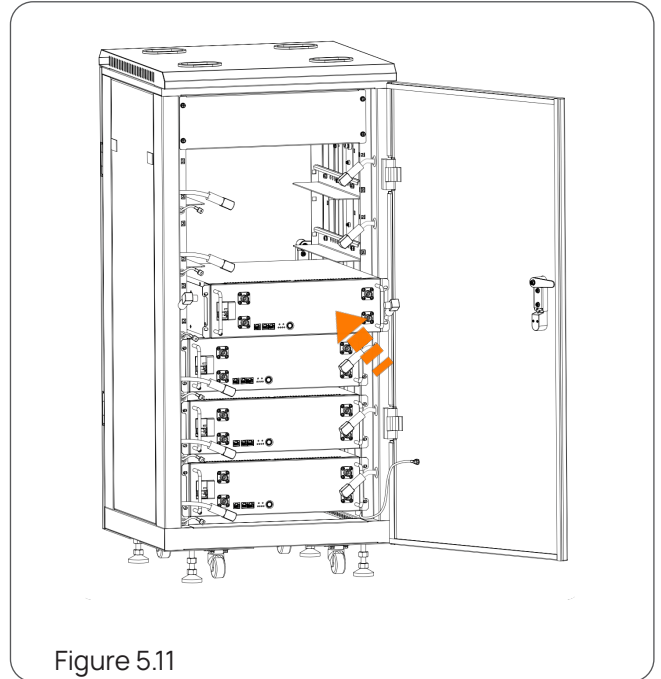

Figure 5.11

5.8.2 Fix the modules to the cabinet

After sliding all the batteries in, tighten the bolts to fix the batteries with torque of 5 Nm.



Figure 5.12

Torque = 5 Nm

5.9 Cables connection

5.9.1 Connect PE Cables

Screw the PE cables as shown in the picture below

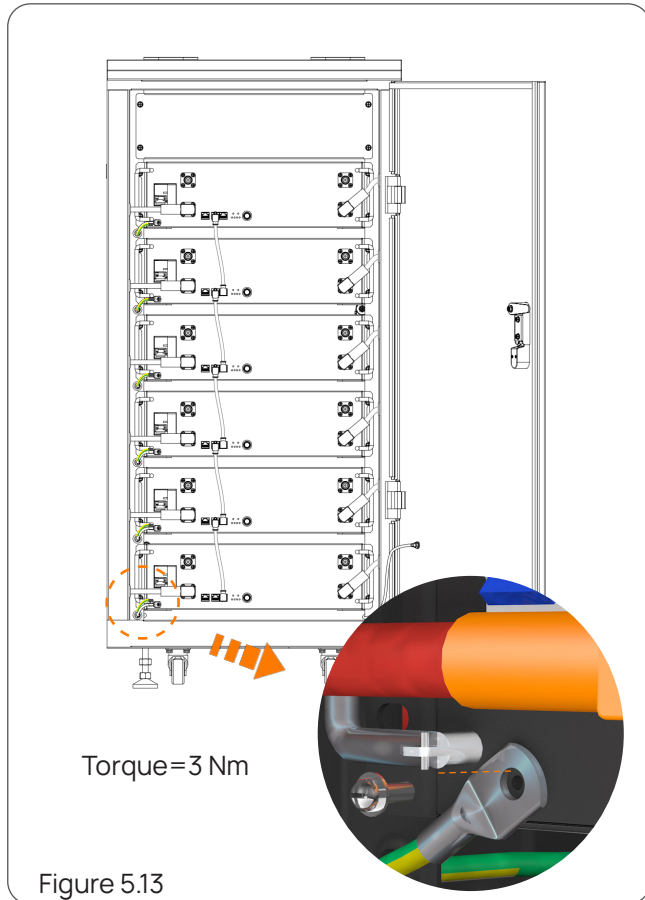

Figure 5.13

5.9.2 Connect Power Cables

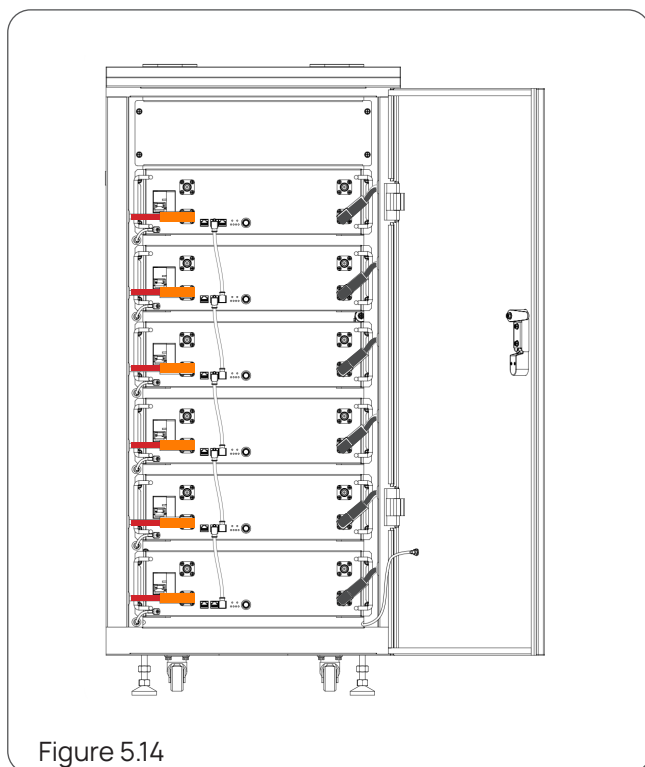

Figure 5.14

***Please ensure you hear a clicking sound to confirm that the power cable is securely connected to the terminal.**

5.9.3 Connect Communication Cables

Connect the communication cable between the Wifi module and the **IN** port of the battery unit on top(which is called the master battery). Then connect the **OUT** port of the master battery to the **IN** port of the next battery. Do the same to the rest batteries.

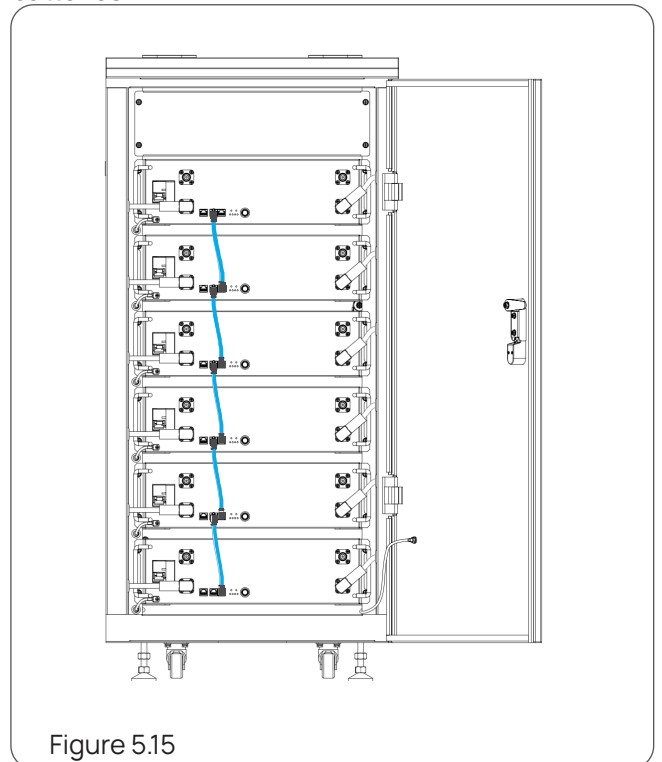

Figure 5.15

5.9.4 Insert Terminal resistor

Insert the terminal resistor to the **OUT** port of the last module.

After the insert of the shorting terminal, this system is ready to go.

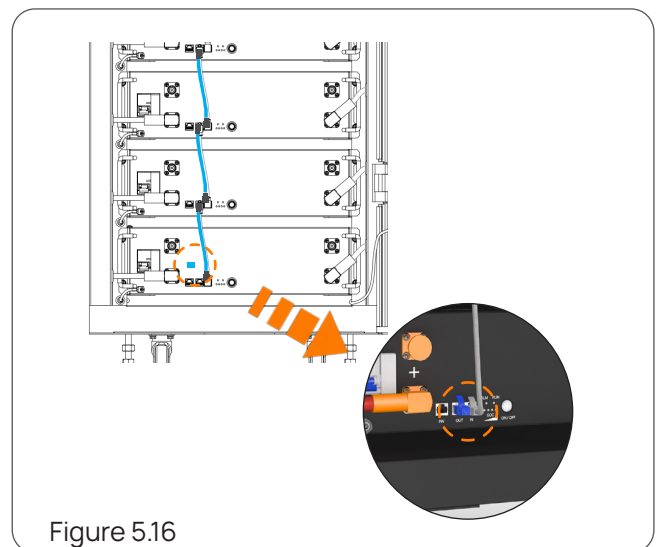

Figure 5.16

5.10 Connect To The Inverter

This is the last step of the installation and it is also easy-operating and time-saving. Connect the power cables and communication cable between battery system and inverter.

Notice:

- Please choose isolated inverters.
- The communication cable between the inverter and the battery should be connected to the **INV** port of master battery. Shown as below. The communication cable should be Cat 5 or upper.
- For no communication mode, there is no need to connect the communication cable.

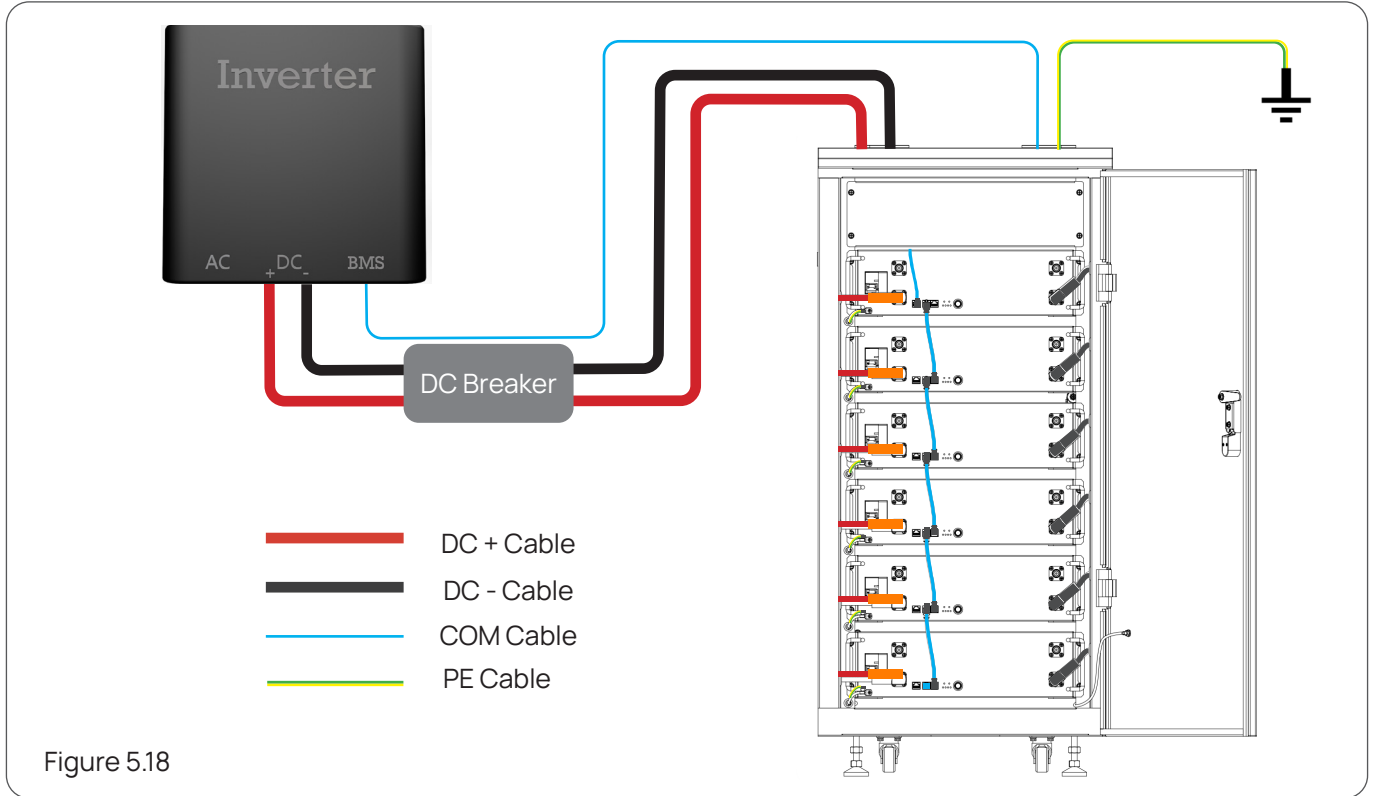

Figure 5.18

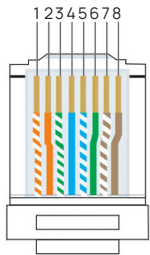

Table 5.2 Definition of INV Port on Battery interface

PIN No.	1	2	3	4	5	6	7	8
Definition	Reserved	Reserved	Reserved	CAN_H	CAN_L	Reserved	RS485B	RS485A

Change the communication cable's wires order if necessary.

Table 5.3 Matching with the **CAN** Communication inverters as below:

	SIMPO 5000	Victron*	Selectronic	SMA	Studer	Steca	Deye	Noark	GoodWe
CAN_H	4	7	1	4	4	4	4	4	4
CAN_L	5	8	2	5	5	5	5	5	5

*For Victron devices, recommended to use the VE.Can to CAN-bus BMS type A cable.

Table 5.4 Matching with the **RS485** Communication inverters as below:

	SIMPO 5000	Lux Power
RS485A	8	2
RS485B	7	1

5.11 Switch to No Communication Mode

SIMPO 5000 can work without communication with the inverter. And the communication mode is default after power on. To switch to no communication mode, please double click the "ON/OFF" button after battery on, then The SOC indicators will flash two times, indicating the successful mode switch. BMS is with working mode memory function, after the system restarts, it is no need to re-operate. The system will switch to communication mode automatically once the communication cable

between the inverter and the master battery is connected.

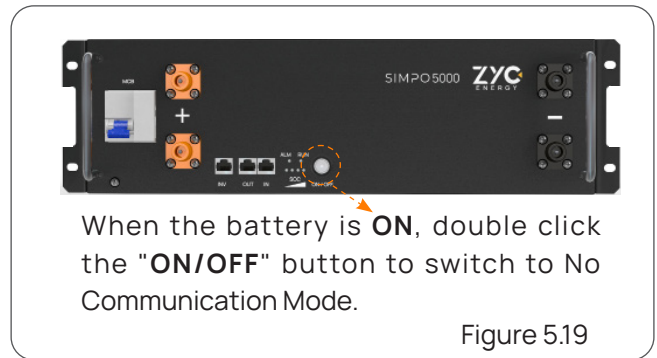

Figure 5.19

5.12 Multiple Cabinets In Parallel

If single cabinet can not meet the energy requirement of your project. Therefore, multiple cabinets in Parallel is needed. This section shows the cabling of multiple cabinets in parallel.

5.12.1 Connect the communication cables between cabinets

Figure 5.20 shows the way of paralleling multiple cabinets. The key connections are linked below: Communication cable should be connected from the OUT port of the last(bottom) battery of the first cabinet, through the pre-drilled hole in the cabinet to the IN port of the bottom battery of the second cabinet. Instead of crossing through the bottom of the first and second cabinet, the connection between the second and the third cabinet should go on top.

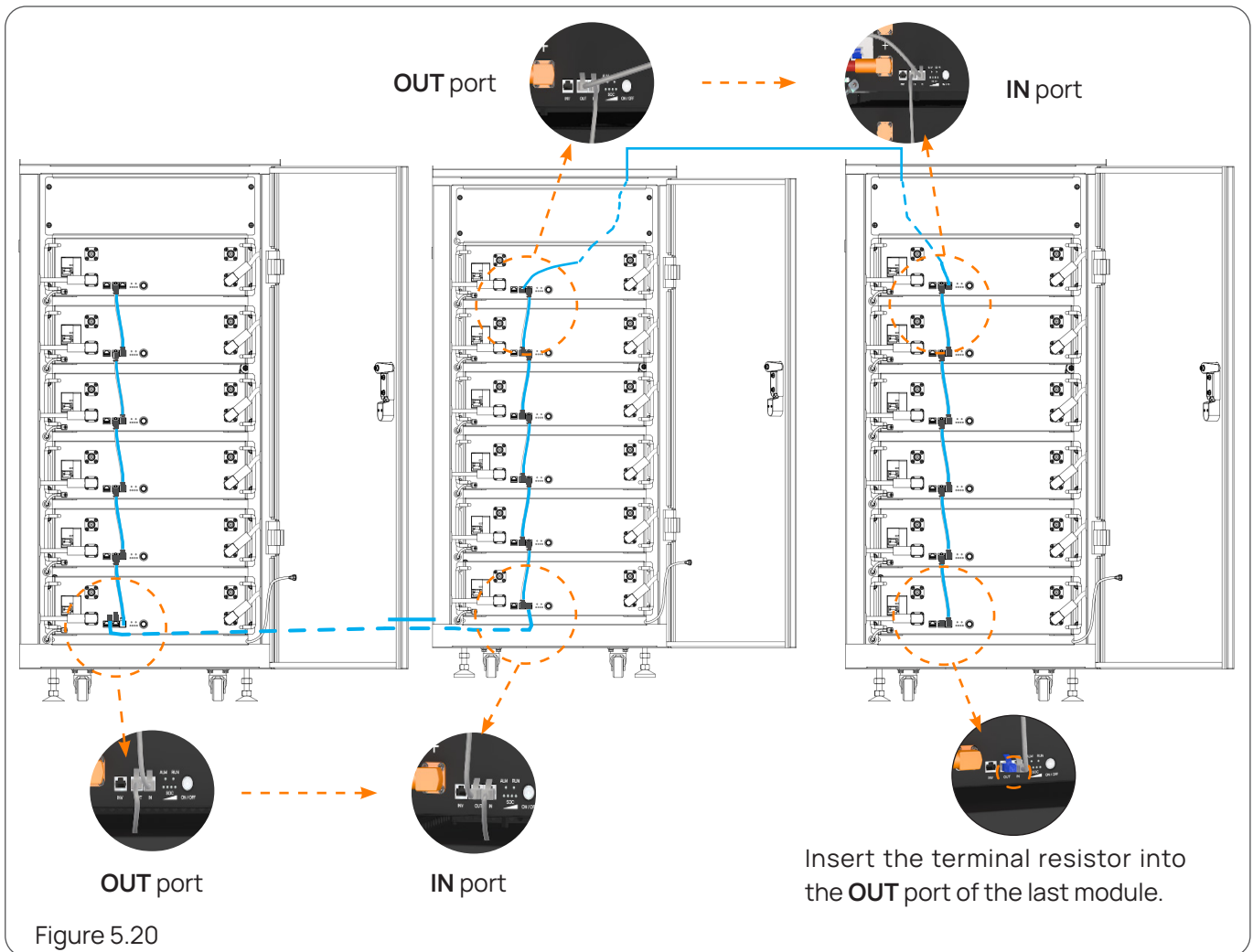

Figure 5.20

5.12.2 Connect the cables between Multi Cabinets and Inverter

Step 1. Connect the PE cable.

Step 2. Connect the power cables of the paralleled cabinets to the DC combiner box and then to the inverter.

Step 3. Connect the communication cable between the master battery and the inverter.

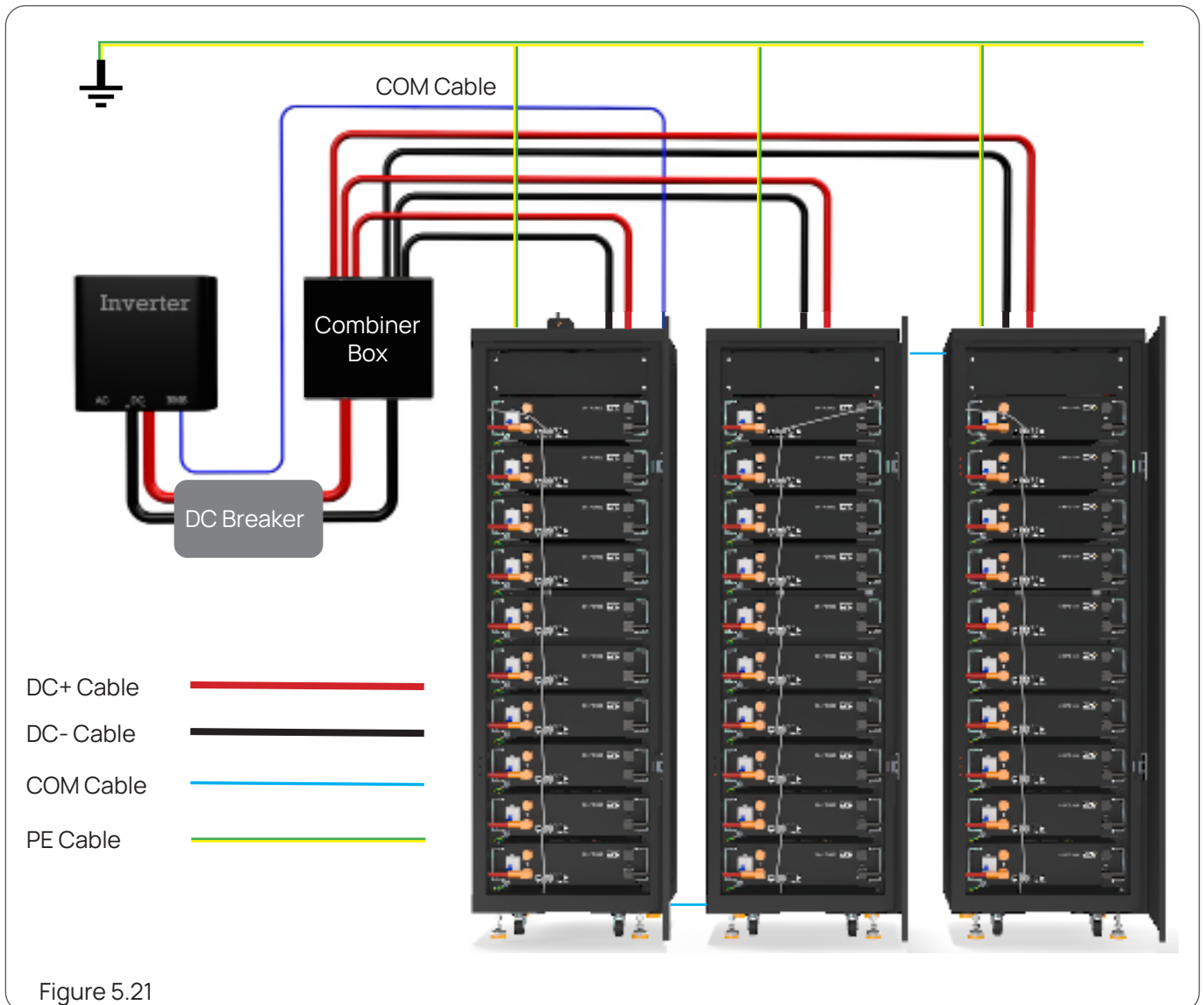

Note:

1. The maximum number of paralleled SIMPO 5000 modules is 64.
2. When multiple cabinets are connected, A DC box is needed to combine the power cables from the cabinets.
3. The DC power cable length for all the cabinets should be approximately equal.
4. The communication cable length ≤ 5 m.

5.13 Installation Without SIMPO Cabinet

It is recommended to install and use SIMPO 5000 in conjunction with SIMPO Cabinet. However, SIMPO 5000 can also be installed in other brands of cabinets or used alone without a cabinet, in which case please follow the guidance below.

5.13.1 Install and use SIMPO 5000 in non-SIMPO Cabinet

SIMPO 5000 can be slide into any 19-inch cabinets seamlessly. When using other cabinets, notice below should be followed:

- SIMPO 5000 should not be installed in the reverse direction.
- For safety reasons, please install SIMPO 5000 from the bottom to the top of the cabinet.
- Select proper size power cables according to the power of system. Refer to section 5.5 if needed.
- Make sure the PE cable is connected properly.
- Connect the communication cable between modules following the guidance in section 5.9.3 and 5.9.4. For multiple cabinets, connect the communication cables base on section 5.12.2 and the selected cabinets.

5.13.2 Install and use SIMPO 5000 without cabinets

In addition to using cabinets, SIMPO 5000 can be used with SIMPO Bracket. SIMPO Bracket allows the stacking of up to 4 modules. When installing SIMPO 5000 with SIMPO Bracket, please select the appropriate power cables, PE cables and communication cables according to your system power and section 5.5. SIMPO 5000 can also be used alone on the floor. In this case, place SIMPO 5000 upright with the front panel facing upwards and find a suitable way to secure it. Avoid insecurity caused by battery collapsing. Select the appropriate power cables, PE cables and communication cables according to your system power and section 5.5.

5.13.3 System Build Up With SIMPO Bracket

SIMPO Bracket is designed by ZYC ENERGY for use in none-cabinet installation.

Bracket Overview

SIMPO Bracket is consist of two components as below.

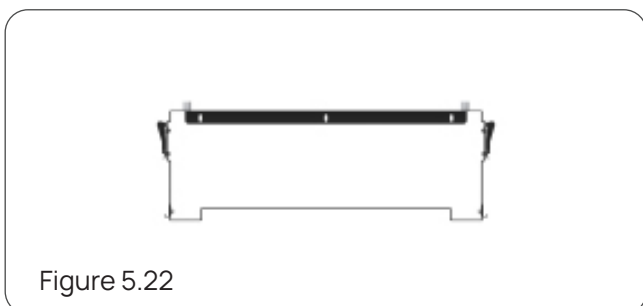

Installation

Step 1

Remove three screws on the back of top cover

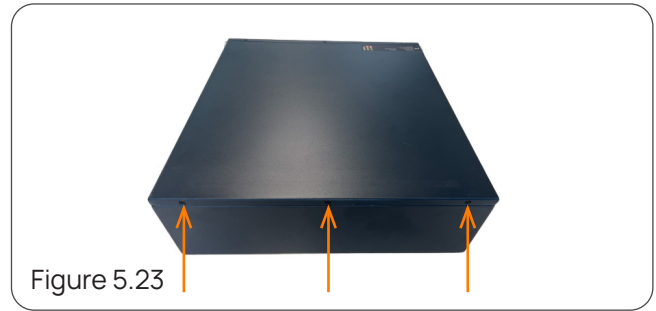

Step 2

Install bracket to the back of SIMPO 5000

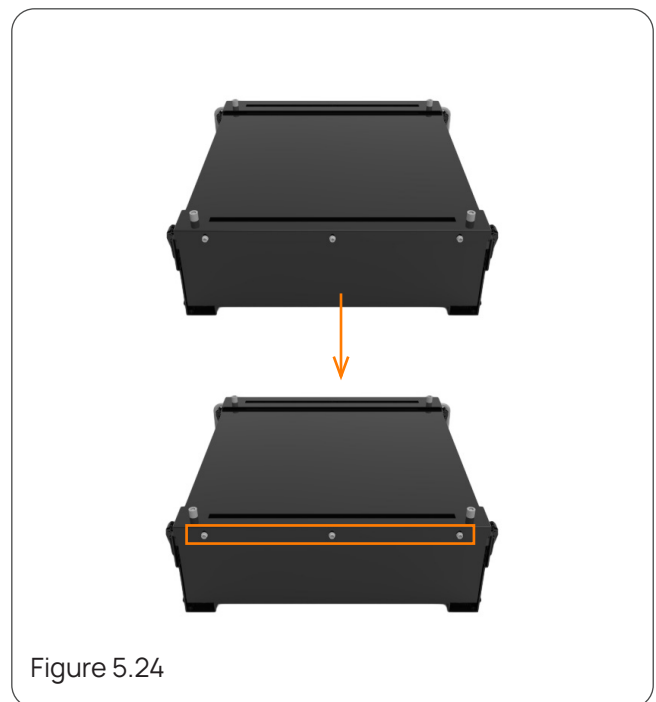

Regarding that SIMPO 5000 is heavy, it is suggested to place the component on the floor, then insert SIMPO 5000 from above, afterwards lay the SIMPO 5000 flat and tighten the three screws on the bracket

Step 3

Install bracket to the front of SIMPO 5000 and tighten the two screws on both side.



Step 4

With the special design of SIMPO Bracket, modules can be stacked up via the four columns and holes on top/bottom of the bracket.

After stacking up modules, follow the steps below to lock the bracket and fix the paralleled modules.

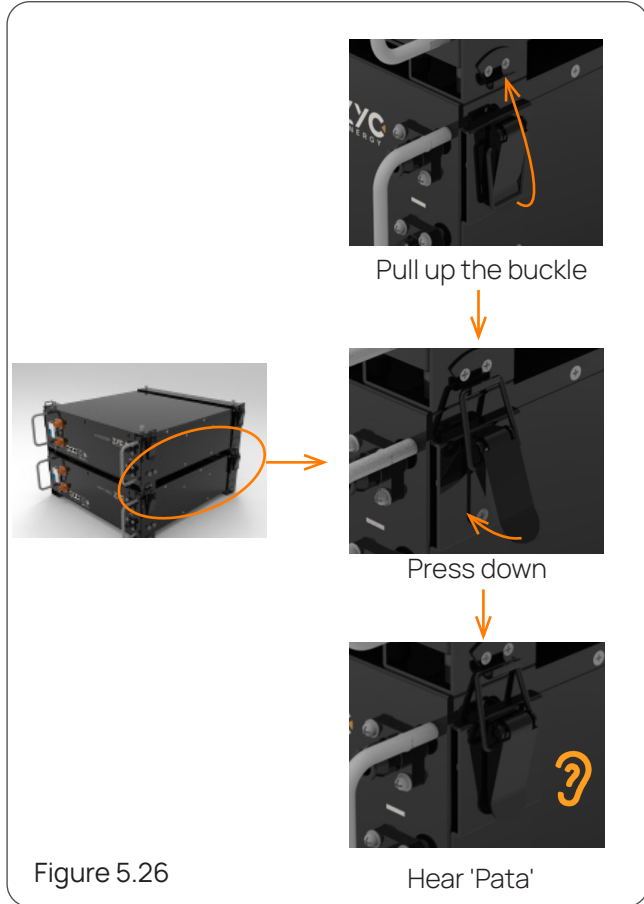

Figure 5.26

5.14 Battery Orientation

When mount SIMPO 5000 without cabinets or bracket. There are certain requirements for the orientation of the battery, please install it correctly according to the following contents.

Battery Orientation For Stationary Applications

When brackets and cabinets are not applicable for use with the battery, avoid placing the battery upside down or placing the front panel directly on the ground. In addition to these two cases, SIMPO5000 allows four other possible orientations for mounting and use:

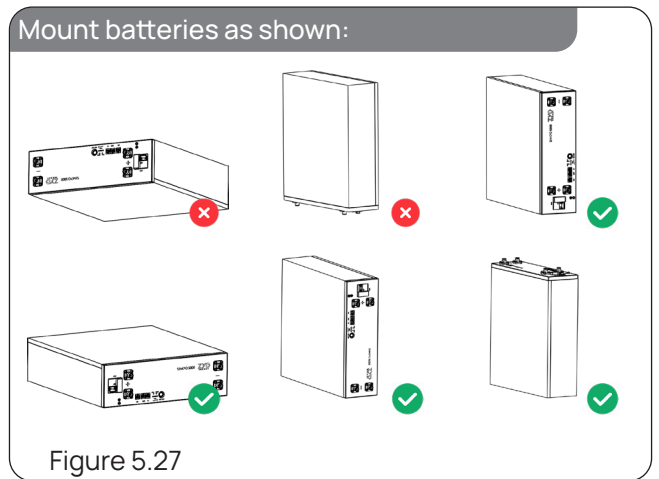

Figure 5.27

Battery Orientation When Wall Mounted

When mount the batteries on wall, please make sure that the batteries are fixed firmly, as the weight of a single module is 44kg, and there is a high risk of accidents and serious damage to the battery if it is dropped. Please first check the following permissible battery orientations before installation.

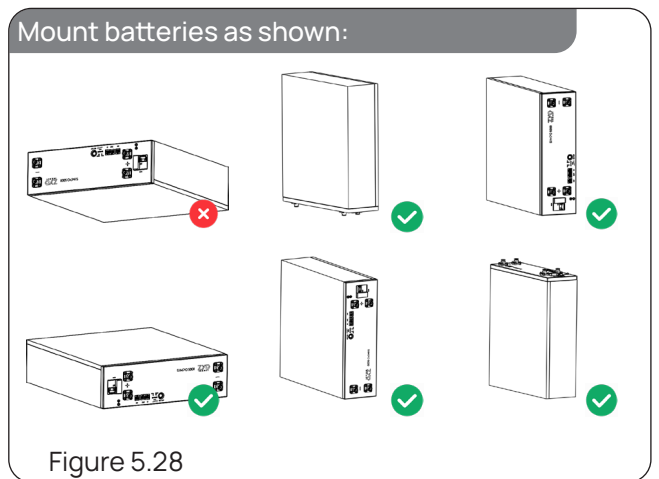

Figure 5.28

5.15 Cables Connection Between Modules

When parallel multiple modules without SIMPO Cabinet or any pre-wired cabinets, please use SIMPO Bracket and connect the power cables and PE cables as shown in figure 5.22:

- Connect the power cables and communication cable of master battery to the inverter.
- *Please ensure you hear a clicking sound to confirm that the power cable is securely connected to the terminal.**
- Connect all PE cables to the ground separately
- Connect communication cable as section 5.9.3
- Insert the terminal resistor

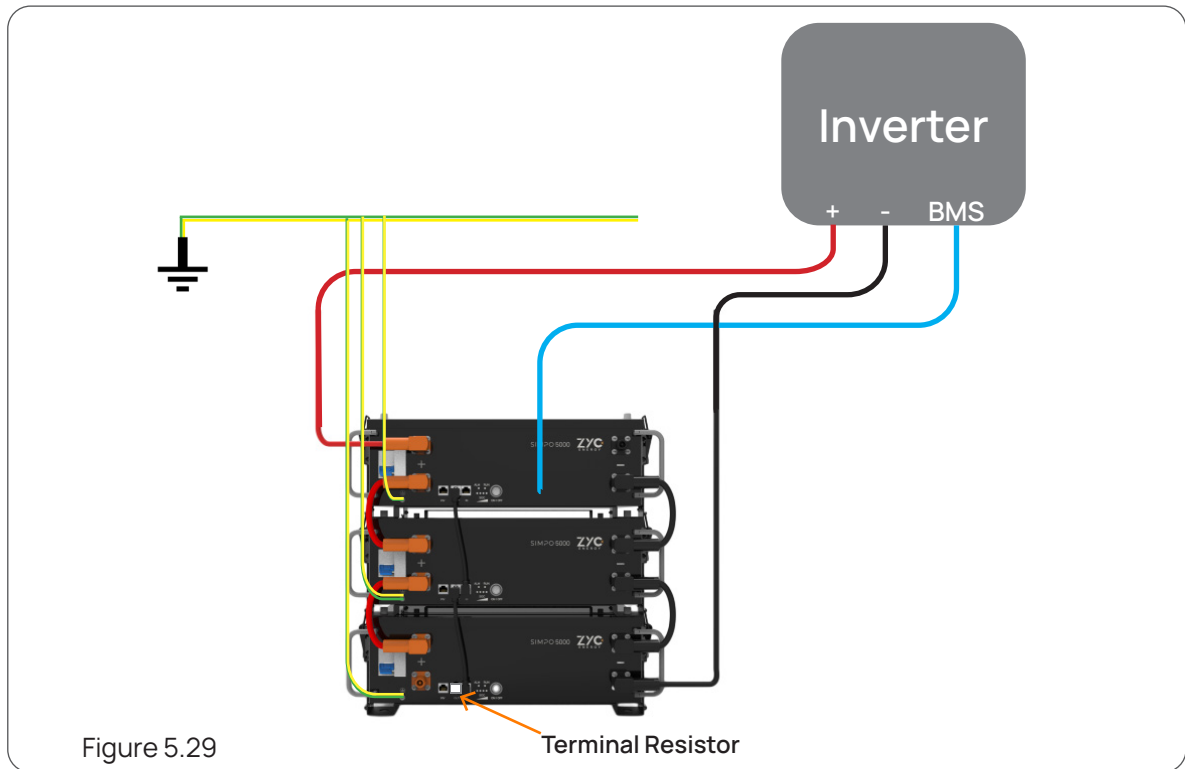

Figure 5.29

Terminal Resistor

6.Commissioning

6.1 Status LED

There are three LEDs on the front panel of SIMPO 5000 that indicate battery status,ALM, RUN and SOC.

Table 6.1 Definition of LEDs' Status

LED	Status	Operational State
ALM	On	Error occurs
	Off	There is no error existing
RUN	On	Battery is working in communication with inverter
	Flash slowly(1.5s On, then1.5s Off)	Battery is working in no-communication mode
	Off	The battery is not working
SOC	Different number of lights are on	Battery capacity is at different level

6.2 Air Switch

We have an air switch for each battery. The air switch is equivalent to the main ON/OFF button of the battery, and the battery can be started only when it is ON. It protects the battery by disconnecting it in time in case of overcurrent or short circuit or overvoltage or overdischarging and it also protects the battery in case of internal failure.

6.3 System Start Up

Before starting the system, please check the wiring connections and make sure that all battery connections are correct and secure, then you can start the system in the following order.

1. Turn on the DC breaker between battery and inverter (If any).
2. Turn on all of the MCBs.
3. Press the 'ON/OFF' button of Master battery for 1s to power on batteries.
4. Turn on the inverter.

Note: For no communication mode settings, please refer to "*Inverter settings of SIMPO 5000*".



IMPORTANT

If the power system has been shut down or charging source has been removed, the air switch should be turned off promptly.

6.4 System Shutdown

It is also easy to shut down the battery system, please follow the steps below to complete:

1. Shut down the inverter.
2. Turn off the DC breaker between battery and inverter (If any).
3. Press and hold the ON/OFF button for 3 seconds on the Master battery to shut it down.
4. Make sure the LED on the battery is off.

6.5 Charging And Discharging

Simpo 5000 is a very powerful battery, equipped with the latest low temperature technology. Making it not only able to discharge at -20°C , but also allows charging at -10°C . The charging temperature is recommended to be between $-10^{\circ}\text{C}\sim 55^{\circ}\text{C}$ and discharging temperature is between $-20^{\circ}\text{C}\sim 55^{\circ}\text{C}$. When discharging, Simpo5000 can provide a

continuous current of 100A and a peak current of 200A for up to 5 seconds. When charging, please ensure that the current through the battery does not exceed 100A.

7.SIMPO WiFi Dongle

7.1 Introduction

This SIMPO WiFi Dongle is plug-and-play and easy to use. It will be able to provide more advanced features such as remote monitoring, local check battery status, running data, firmware upgrades, etc.

It is highly recommended to buy a SIMPO WiFi Dongle from ZYC and connect the battery system to the Internet.

* Working Mode Priority:

- **AP(Local Access):** Connect the hotspot of the SIMPO WIFI with a mobile device to work in AP mode.
- **STA(To Internet):** There are two options to connect to the internet with SIMPO WIFI.
 1. Connect SIMPO WIFI to the router directly with a network cable.
 2. Set up a wireless connection for SIMPO WIFI dongle through ZYC Assist APP.

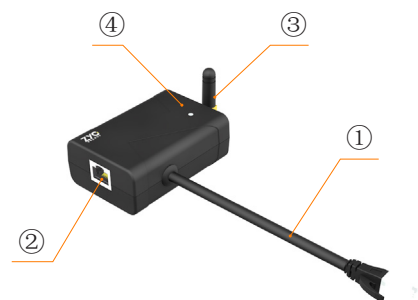

Figure 7.1

S.N.	Name	Remarks
①	BMS Cable	Connect to "IN" Port of Master battery. (Cable length: 50 cm)
②	Ethernet	Connect to router through network cable
③	Antenna	Wireless WiFi Hotspot Amplifier
④	Indicator*	Show the status of working mode.

* Indicator State:

- Solid OFF: Non-Connection.
- Solid ON: Local Communication (AP).
- Flash Flowly: Connecting Internet (STA).
- Flash Quickly: Data in transit.

7.2 Connect to Internet & WiFi Usage & ZYC Portal & ZYC Assist APP

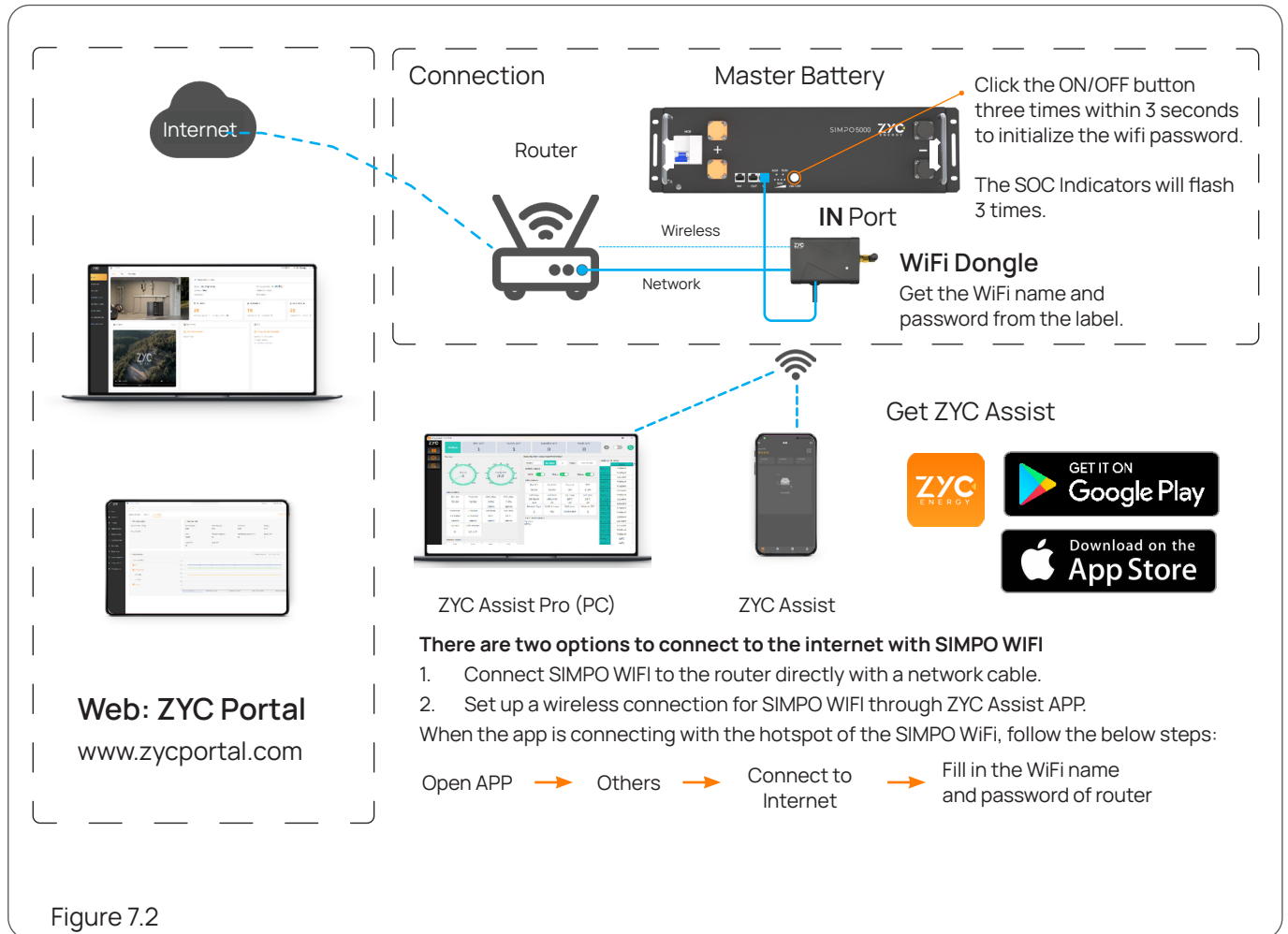

Figure 7.2

7.3 Download ZYC Assist APP

Search "ZYC Assist" in Google Play or App Store.

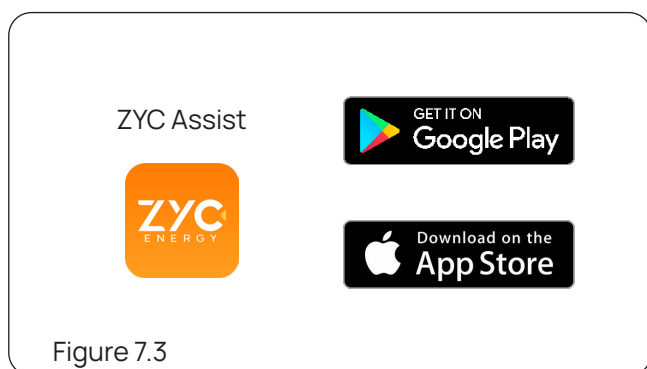

Figure 7.3

For more details for using of ZYC Assist, please refer to *User Guideline of ZYC Assist*.

8. Trouble Shooting

Please refer to the *Service Guideline*.

9. Compatible Inverters

For the latest inverter compatibility list, please visit the www.zyc.energy website and find the *SIMPO 5000 Recommended List* or *Inverter Setting Guide for SIMPO 5000* (For no communication with inverter).

10. Maintenance

SIMPO 5000 does not require frequent maintenance. However, as part of your overall system maintenance, some checks can be carried out at least yearly.

- Check Status LED.
- Check battery connections and cables for secure fitting or damage.
- Check for any obstruction placed around the battery or battery enclosure.
- Check for animals, insects or creatures nesting in or around the battery enclosure.
- Check for build-up of any foreign objects in or around the cabinet.

11. Long-term Storage

The battery voltage should be checked if the SIMPO 5000 batteries stored for long periods of time (≥ 6 months):

- If the battery voltage is higher than 51.6V, the battery is in good condition and does not need to be charged. After that the batteries should be checked every 3 months.
- If the battery voltage is lower than 51.6V, the battery should be charged to prevent irreversible damage caused by low battery power. It is recommended to charge the battery with 55VDC charging voltage and 10A constant current for about 30 minutes.

12. Date Of Manufacture

To get information related to the date of manufacture of the product, find the serial number on the nameplate of the product, always in format as below:

ZD010M10A0**231106**000001

The bolded number indicates the date of manufacture of the product.

23:Year

11:Month

06:Day

13. Warranty

For more information about the warranty, please visit ZYC Portal on www.zyc.energy and find the *Warranty Letter*.

Contact us



ZYC Energy Australia Pty Ltd



Suite 3 7 Ridge St NORTH SYDNEY NSW2060, AUSTRALIA



+61 2 8006 1868



sales@zyc.energy



ZYC Lithium Batteries S.L.



Calle Angelita Cavero 13 Oficina 4 Madrid (28027), España



+34 697919475



info@zyc-europe.com



ZYC Energy Company Limited



GuangKe Road 1, Pingshan, Shenzhen, P.R. China



+86 (0) 755-2839 4019



sales@zyc.energy



WhatsApp: +86 19168831702



www.zyc.energy